





R-B COMPONENTES

www.rbcomponentes.com



-  GAMA COMPLETA ACTUALIZADA DE CAPOTS.
-  GAMMA COMPLETA DI COFANI AGGIORNATA.
-  GAMME COMPLÈTE MISE À JOUR DE CAPOTS.
-  UPDATED AND COMPLETE RANGE OF COVERS.



 FABRICADO POR Y PARA RBCOMPONENTES
 FABRIQUÉES PAR ET POUR RBCOMPONENTES



FABRICATO DA E PER RBCOMPONENTES
 PRODUCED BY AND FOR RBCOMPONENTES



R-B COMPONENTES





CAPOTS / COFANI / CAPOTS / COVERS



Item n°1 - Ref: RB013554



DESCRIPCIÓN / DESCRIZIONE / DESCRIPTION / DESCRIPTION:

-  CAPOT DE FIBRA, LADO DELANTERO.
-  COFANO IN FIBRA DE VETRO, CENTRALE ANTERIORE.
-  CAPOT EN FIBRE DE VERRE, AVANT CENTRAL
-  FIBER GLASS COVER, FRONT CENTRAL.

ENTREGA / CONSEGNA / LIVRAISON / DELIVERY DATE:

-  IMMEDIATA / IMMEDIATA / IMMÉDIATE / IMMEDIATE.



FABRICADO POR Y PARA RBCOMPONENTES
FABRIQUÉES PAR ET POUR RBCOMPONENTES



FABRICATO DA E PER RBCOMPONENTES
PRODUCED BY AND FOR RBCOMPONENTES

Email / Mail / Email: rbcomponentes@rbcomponentes.com
Movil / Portable / Mobile: +34 696 997 798 / +34 677 677 471





Telf. / Tél. / Phone: +34 976 400 421
Fax / Fax / Fax: +34 976 400 420



Item n°2 - Ref: RB013557



DESCRIPCIÓN / DESCRIZIONE / DESCRIPTION / DESCRIPTION:

-  CAPOT DE FIBRA DE VIDRIO, LADO DERECHO.
-  COFANO IN FIBRA DI VETRO, LATO DESTRO.
-  CAPOT EN FIBRE DE VERRE, CÔTÉ DROIT.
-  FIBER GLASS COVER, RIGHT SIDE.





ENTREGA / CONSEGNA / LIVRAISON / DELIVERY DATE:

 IMMEDIATA / IMMEDIATA / IMMÉDIATE / IMMEDIATE.

Item n°3 - Ref: RB013558



DESCRIPCIÓN / DESCRIZIONE / DESCRIPTION / DESCRIPTION:

-  CAPOT DE FIBRA, LADO IZQUIERDO.
-  COFANO IN FIBRA DI VETRO, LATO SINISTRO.
-  CAPOT EN FIBRE DE VERRE, CÔTÉ GAUCHE.
-  FIBER GLASS COVER, LEFT SIDE.





ENTREGA / CONSEGNA / LIVRAISON / DELIVERY DATE:

 IMMEDIATA / IMMEDIATA / IMMÉDIATE / IMMEDIATE.

Item n°4 - Ref: RB013555



DESCRIPCIÓN / DESCRIZIONE / DESCRIPTION / DESCRIPTION:

-  CAPOT DE FIBRA DE VIDRIO, GUARDABARROS DERECHO.
-  COFANO IN FIBRA DI VETRO, PARAFANGO DESTRO.
-  CAPOT EN FIBRE DE VERRE, GARDE-BOUE DROIT.
-  FIBER GLASS COVER, MUDGUARD RIGHT SIDE.





ENTREGA / CONSEGNA / LIVRAISON / DELIVERY DATE:

 IMMEDIATA / IMMEDIATA / IMMÉDIATE / IMMEDIATE.

Item n°5 - Ref: RB013556



DESCRIPCIÓN / DESCRIZIONE / DESCRIPTION / DESCRIPTION:

-  CAPOT DE FIBRA DE VIDRIO, GUARDABARROS IZQUIERDO.
-  COFANO IN FIBRA DI VETRO, PARAFANGO DI SINISTRA.
-  CAPOT EN FIBRE DE VERRE, GARDE-BOUE GAUCHE.
-  FIBER GLASS COVER, MUDGUARD LEFT SIDE.

ENTREGA / CONSEGNA / LIVRAISON / DELIVERY DATE:

 IMMEDIATA / IMMEDIATA / IMMÉDIATE / IMMEDIATE.



FABRICADO POR Y PARA RBCOMPONENTES
FABRIQUÉES PAR ET POUR RBCOMPONENTES







FABRICATO DA E PER RBCOMPONENTES
PRODUCED BY AND FOR RBCOMPONENTES



Item n°1 - Ref: RB013523



DESCRIPCIÓN / DESCRIZIONE / DESCRIPTION / DESCRIPTION:

-  CAPOT DE FIBRA, LADO DELANTERO.
-  COFANO IN FIBRA DE VETRO, CENTRALE ANTERIORE.
-  CAPOT EN FIBRE DE VERRE, AVANT CENTRAL
-  FIBER GLASS COVER, FRONT CENTRAL.

ENTREGA / CONSEGNA / LIVRAISON / DELIVERY DATE:

 IMMEDIATA / IMMEDIATA / IMMÉDIATE / IMMEDIATE.



FABRICADO POR Y PARA RBCOMPONENTES
FABRIQUÉES PAR ET POUR RBCOMPONENTES







FABRICATO DA E PER RBCOMPONENTES
PRODUCED BY AND FOR RBCOMPONENTES



Item n°2 - Ref: RB013525



DESCRIPCIÓN / DESCRIZIONE / DESCRIPTION / DESCRIPTION:

-  CAPOT DE FIBRA, LADO IZQUIERDO.
-  COFANO IN FIBRA DI VETRO, LATO SINISTRO.
-  CAPOT EN FIBRE DE VERRE, CÔTÉ GAUCHE.
-  FIBER GLASS COVER, LEFT SIDE.





ENTREGA / CONSEGNA / LIVRAISON / DELIVERY DATE:

 IMMEDIATA / IMMEDIATA / IMMÉDIATE / IMMEDIATE.

Item n°3 - Ref: RB013524



DESCRIPCIÓN / DESCRIZIONE / DESCRIPTION / DESCRIPTION:

-  CAPOT DE FIBRA DE VIDRIO, LADO DERECHO.
-  COFANO IN FIBRA DI VETRO, LATO DESTRO.
-  CAPOT EN FIBRE DE VERRE, CÔTÉ DROIT.
-  FIBER GLASS COVER, RIGHT SIDE.





ENTREGA / CONSEGNA / LIVRAISON / DELIVERY DATE:

 IMMEDIATA / IMMEDIATA / IMMÉDIATE / IMMEDIATE.

Item n°4 - Ref: RB013522



DESCRIPCIÓN / DESCRIZIONE / DESCRIPTION / DESCRIPTION:

-  CAPOT DE FIBRA DE VIDRIO, GUARDABARROS IZQUIERDO.
-  COFANO IN FIBRA DI VETRO, PARAFANGO DI SINISTRA.
-  CAPOT EN FIBRE DE VERRE, GARDE-BOUE GAUCHE.
-  FIBER GLASS COVER, MUDGUARD LEFT SIDE.





ENTREGA / CONSEGNA / LIVRAISON / DELIVERY DATE:

 IMMEDIATA / IMMEDIATA / IMMÉDIATE / IMMEDIATE.

Item n°5 - Ref: RB013521



DESCRIPCIÓN / DESCRIZIONE / DESCRIPTION / DESCRIPTION:



-  CAPOT DE FIBRA DE VIDRIO, GUARDABARROS DERECHO.
-  COFANO IN FIBRA DI VETRO, PARAFANGO DESTRO.
-  CAPOT EN FIBRE DE VERRE, GARDE-BOUE DROIT.
-  FIBER GLASS COVER, MUDGUARD RIGHT SIDE.

ENTREGA / CONSEGNA / LIVRAISON / DELIVERY DATE:

 IMMEDIATA / IMMEDIATA / IMMÉDIATE / IMMEDIATE.



 FABRICADO POR Y PARA RBCOMPONENTES
 FABRIQUÉES PAR ET POUR RBCOMPONENTES

 FABRICATO DA E PER RBCOMPONENTES
 PRODUCED BY AND FOR RBCOMPONENTES



R-B COMPONENTES

CAPOTS / COFANI / CAPOTS / COVERS



FABRICADO POR Y PARA RBCOMPONENTES
FABRIQUÉES PAR ET POUR RBCOMPONENTES



FABRICATO DA E PER RBCOMPONENTES
PRODUCED BY AND FOR RBCOMPONENTES

Email / Mail / Email: rbcomponentes@rbcomponentes.com
Movil / Portable / Mobile: +34 696 997 798 / +34 677 677 471





Telf. / Tél. / Phone: +34 976 400 421
Fax / Fax / Fax: +34 976 400 420



Item n°1A - Ref: RB013504



DESCRIPCIÓN / DESCRIZIONE / DESCRIPTION / DESCRIPTION:

-  ANTIGUA VERSION DE CAPOT, LADO IZQUIERDO.
-  VECCHIA VERSIONE DI COFANO, LATO SINISTRO.
-  ANCIENNE VERSION DE CAPOT, CÔTÉ GAUCHE.
-  OLD VERSION OF COVER, LEFT SIDE.





ENTREGA / CONSEGNA / LIVRAISON / DELIVERY DATE:

 IMMEDIATA / IMMÉDIATE / IMMEDIATE.

Item n°2A - Ref: RB013505



DESCRIPCIÓN / DESCRIZIONE / DESCRIPTION / DESCRIPTION:

-  ANTIGUA VERSION DE CAPOT, LADO DERECHO.
-  VECCHIA VERSIONE DI COFANO, LATO DESTRO.
-  ANCIENNE VERSION DE CAPOT, CÔTÉ DROIT.
-  OLD VERSION OF COVER, RIGHT SIDE.





ENTREGA / CONSEGNA / LIVRAISON / DELIVERY DATE:

 IMMEDIATA / IMMÉDIATE / IMMEDIATE.

Item n°1B - Ref: RB013513



DESCRIPCIÓN / DESCRIZIONE / DESCRIPTION / DESCRIPTION:

-  NUEVA VERSION DE CAPOT, LADO IZQUIERDO.
-  NUOVA VERSIONE DI COFANO, LATO SINISTRO.
-  NOUVELLE VERSION DE CAPOT, CÔTÉ GAUCHE.
-  NEW VERSION OF COVER, LEFT SIDE.





ENTREGA / CONSEGNA / LIVRAISON / DELIVERY DATE:

 IMMEDIATA / IMMÉDIATE / IMMEDIATE.

Item n°2B - Ref: RB013514



DESCRIPCIÓN / DESCRIZIONE / DESCRIPTION / DESCRIPTION:

-  NUEVA VERSION DE CAPOT, LADO DERECHO.
-  NUOVA VERSIONE DI COFANO, LATO DESTRO.
-  NOUVELLE VERSION DE CAPOT, CÔTÉ DROIT.
-  NEW VERSION OF COVER, RIGHT SIDE.

ENTREGA / CONSEGNA / LIVRAISON / DELIVERY DATE:

 IMMEDIATA / IMMÉDIATE / IMMEDIATE.



FABRICADO POR Y PARA RBCOMPONENTES
FABRIQUÉES PAR ET POUR RBCOMPONENTES





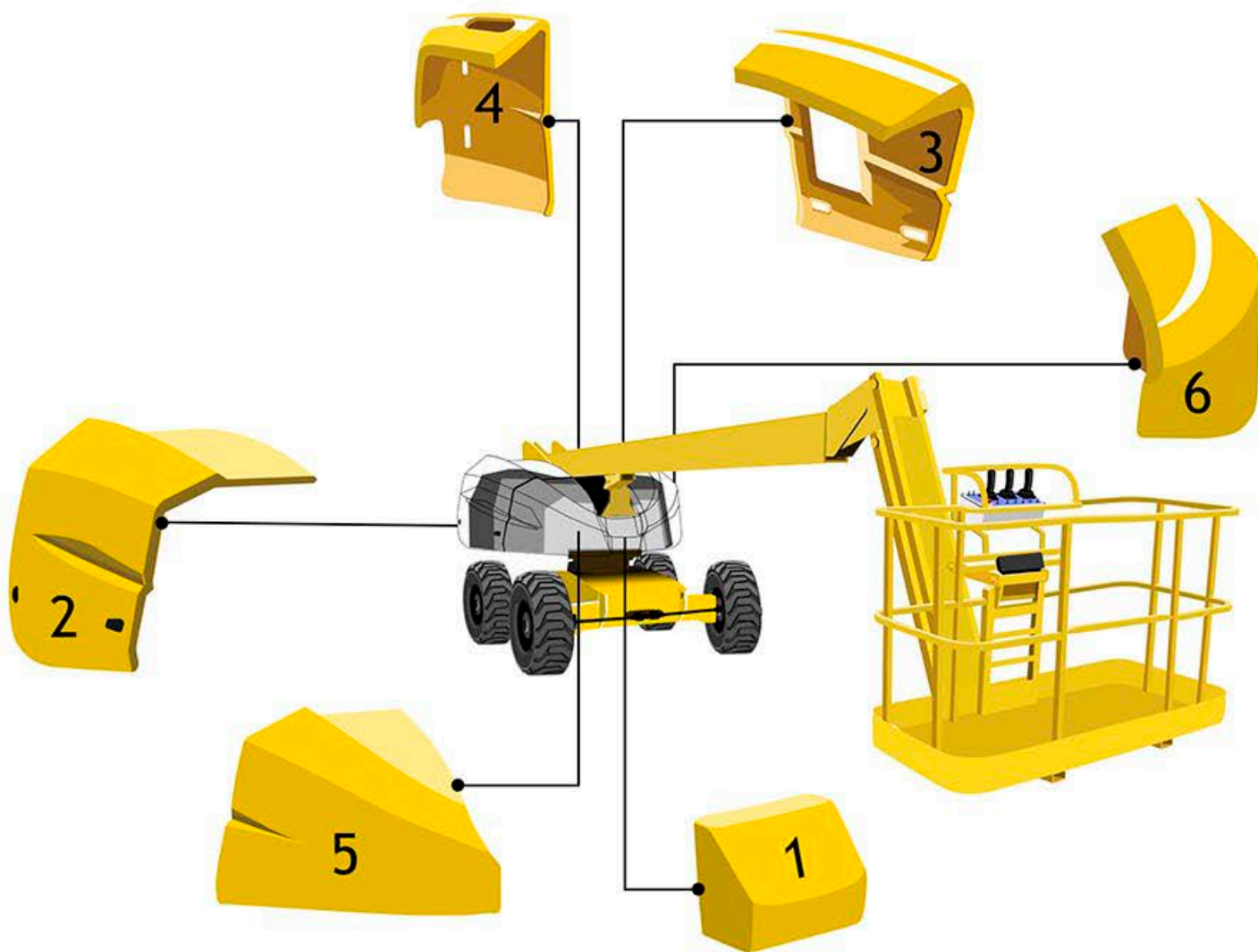

FABRICATO DA E PER RBCOMPONENTES
PRODUCED BY AND FOR RBCOMPONENTES



Item n°1 - Ref: RB013535





DESCRIPCIÓN / DESCRIZIONE / DESCRIPTION / DESCRIPTION:

-  CAPOT DE FIBRA, LADO DELANTERO.
-  COFANO IN FIBRA DE VETRO, CENTRALE ANTERIORE.
-  CAPOT EN FIBRE DE VERRE, AVANT CENTRAL
-  FIBER GLASS COVER, FRONT CENTRAL.

ENTREGA / CONSEGNA / LIVRAISON / DELIVERY DATE:

-  IMMEDIATA / IMMEDIATA / IMMÉDIATE / IMMEDIATE.

 FABRICADO POR Y PARA RBCOMPONENTES
 FABRIQUÉES PAR ET POUR RBCOMPONENTES





 FABRICATO DA E PER RBCOMPONENTES
 PRODUCED BY AND FOR RBCOMPONENTES



Item n°2 - Ref: RB013530



DESCRIPCIÓN / DESCRIZIONE / DESCRIPTION / DESCRIPTION:

-  CAPOT DE FIBRA DE VIDRIO, LADO DERECHO TRASERO.
-  COFANO IN FIBRA DI VETRO, LATO DESTRO POSTERIORE.
-  CAPOT EN FIBRE DE VERRE, CÔTÉ ARRIÈRE DROIT.
-  FIBER GLASS COVER, REAR RIGHT SIDE.





ENTREGA / CONSEGNA / LIVRAISON / DELIVERY DATE:

 IMMEDIATA / IMMEDIATA / IMMÉDIATE / IMMEDIATE.

Item n°3 - Ref: RB013532



DESCRIPCIÓN / DESCRIZIONE / DESCRIPTION / DESCRIPTION:

-  CAPOT DE FIBRA, CUERPO CENTRAL IZQUIERDO.
-  COFANO IN FIBRA DI VETRO, CORPO CENTRALE DI SINISTRA.
-  CAPOT EN FIBRE DE VERRE, CORPS CENTRAL CÔTÉ GAUCHE.
-  FIBER GLASS COVER, CENTRAL BODY LEFT SIDE.





ENTREGA / CONSEGNA / LIVRAISON / DELIVERY DATE:

 IMMEDIATA / IMMEDIATA / IMMÉDIATE / IMMEDIATE.

Item n°4 - Ref: RB013533



DESCRIPCIÓN / DESCRIZIONE / DESCRIPTION / DESCRIPTION:

-  CAPOT DE FIBRA, LADO IZQUIERDO TRASERO.
-  COFANO IN FIBRA DI VETRO, LATO SINISTRO POSTERIORE.
-  CAPOT EN FIBRE DE VERRE, CÔTÉ ARRIÈRE GAUCHE.
-  FIBER GLASS COVER, REAR LEFT SIDE.

ENTREGA / CONSEGNA / LIVRAISON / DELIVERY DATE:

 IMMEDIATA / IMMEDIATA / IMMÉDIATE / IMMEDIATE.

Item n°5 - Ref: RB013531







DESCRIPCIÓN / DESCRIPTION:

-  LADO DELANTERO DER.
-  LATO DESTRO ANTERIORE.
-  CÔTÉ AVANT DROITE.
-  FRONT RIGHT SIDE.

Item n°6 - Ref: RB013534



DESCRIPCIÓN / DESCRIPTION:

-  LADO DELANTERO IZQ.
-  LATO SINISTRO ANTERIORE.
-  CÔTÉ AVANT GAUCHE.
-  FRONT LEFT SIDE.



FABRICADO POR Y PARA RBCOMPONENTES
FABRIQUÉES PAR ET POUR RBCOMPONENTES



FABRICATO DA E PER RBCOMPONENTES
PRODUCED BY AND FOR RBCOMPONENTES



R-B COMPONENTES

CAPOTS / COFANI / CAPOTS / COVERS

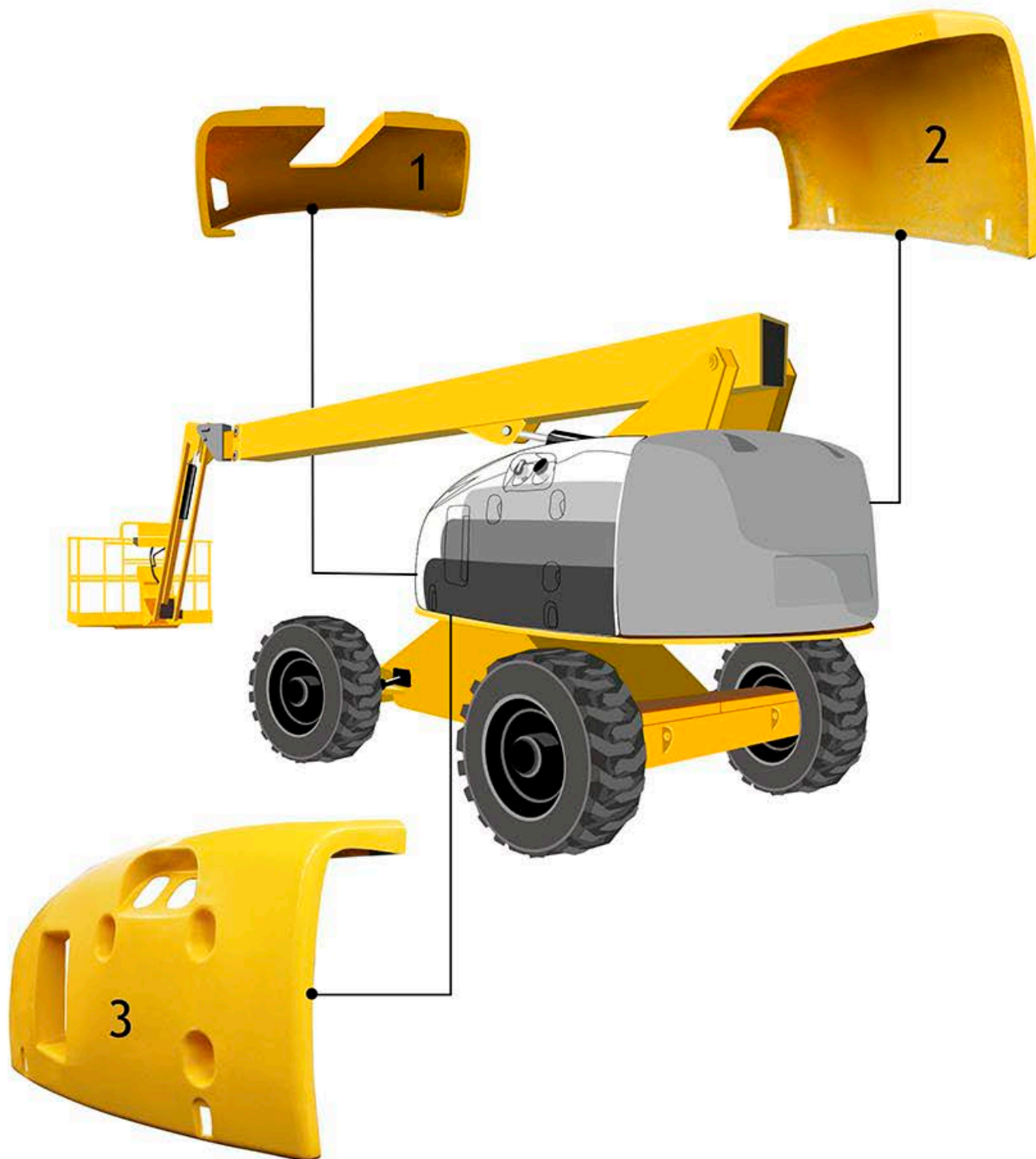

FABRICADO POR Y PARA RBCOMPONENTES
FABRIQUÉES PAR ET POUR RBCOMPONENTES



FABRICATO DA E PER RBCOMPONENTES
PRODUCED BY AND FOR RBCOMPONENTES

Email / Mail / Email: rbcomponentes@rbcomponentes.com
Movil / Portable / Mobile: +34 696 997 798 / +34 677 677 471

Telf. / Tél. / Phone: +34 976 400 421
Fax / Fax / Fax: +34 976 400 420



CAPOTS / COFANI / CAPOTS / COVERS

PEÇAS SOBRESSALENTES

PIÈCES DE REÇANGE





SPARE PARTS

PIEZZI DI RECAMBIO

Item n°1 - Ref: RB013548



DESCRIPCIÓN / DESCRIZIONE / DESCRIPTION / DESCRIPTION:

-  CAPOT DE FIBRA, LADO DELANTERO.
-  COFANO IN FIBRA DE VETRO, CENTRALE ANTERIORE.
-  CAPOT EN FIBRE DE VERRE, AVANT CENTRAL
-  FIBER GLASS COVER, FRONT CENTRAL.





ENTREGA / CONSEGNA / LIVRAISON / DELIVERY DATE:

 IMMEDIATA / IMMEDIATA / IMMÉDIATE / IMMEDIATE.

Item n°2 - Ref: RB013539



DESCRIPCIÓN / DESCRIZIONE / DESCRIPTION / DESCRIPTION:

-  CAPOT DE FIBRA DE VIDRIO, LADO DERECHO.
-  COFANO IN FIBRA DI VETRO, LATO DESTRO.
-  CAPOT EN FIBRE DE VERRE, CÔTÉ DROIT.
-  FIBER GLASS COVER, RIGHT SIDE.





ENTREGA / CONSEGNA / LIVRAISON / DELIVERY DATE:

 IMMEDIATA / IMMEDIATA / IMMÉDIATE / IMMEDIATE.

Item n°3 - Ref: RB013538



DESCRIPCIÓN / DESCRIZIONE / DESCRIPTION / DESCRIPTION:

-  CAPOT DE FIBRA, LADO IZQUIERDO.
-  COFANO IN FIBRA DI VETRO, LATO SINISTRO.
-  CAPOT EN FIBRE DE VERRE, CÔTÉ GAUCHE.
-  FIBER GLASS COVER, LEFT SIDE.

ENTREGA / CONSEGNA / LIVRAISON / DELIVERY DATE:

 IMMEDIATA / IMMEDIATA / IMMÉDIATE / IMMEDIATE.



FABRICADO POR Y PARA RBCOMPONENTES
FABRIQUÉES PAR ET POUR RBCOMPONENTES



FABRICATO DA E PER RBCOMPONENTES
PRODUCED BY AND FOR RBCOMPONENTES



R-B COMPONENTES

CAPOTS / COFANI / CAPOTS / COVERS

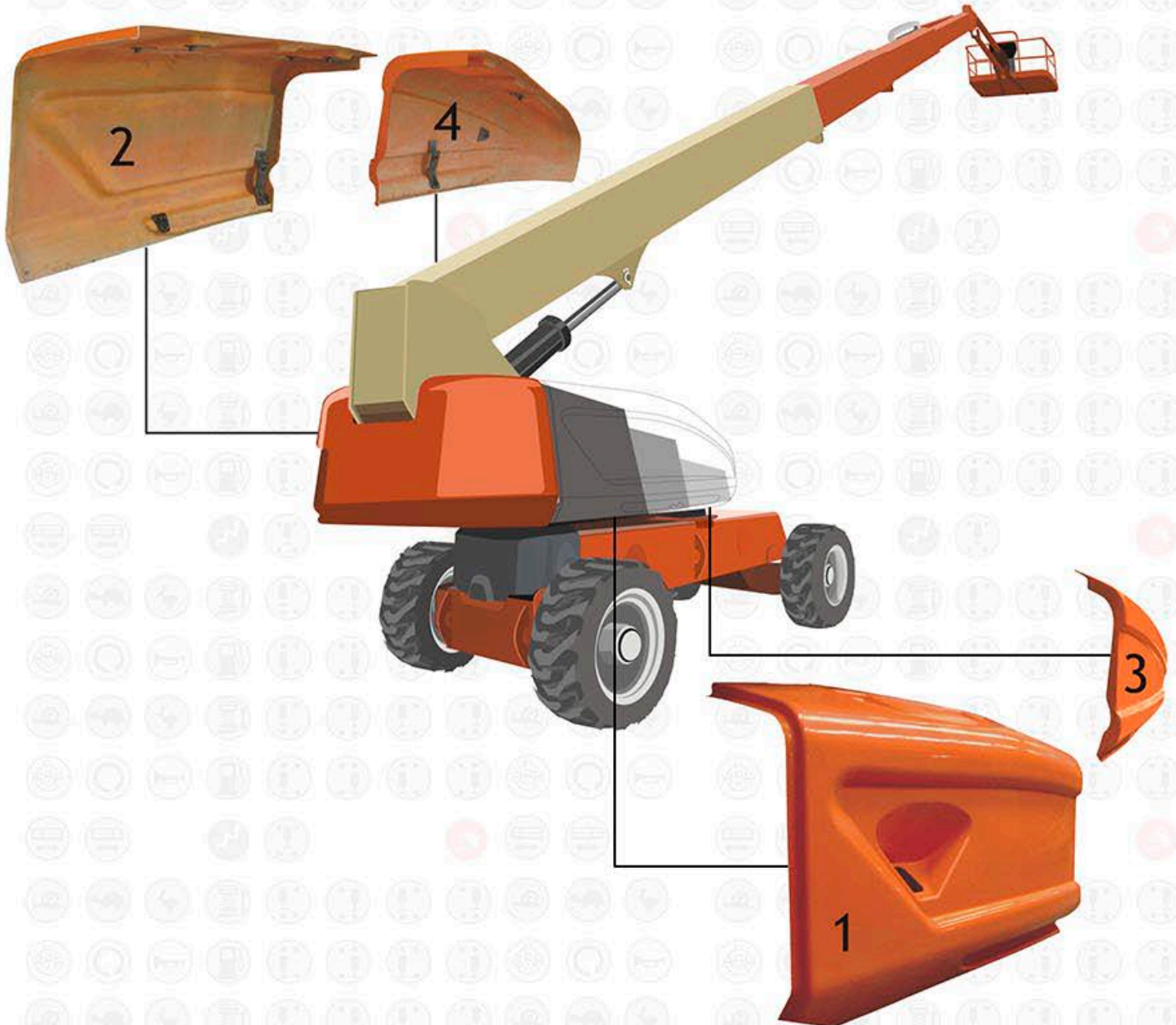

FABRICADO POR Y PARA RBCOMPONENTES
FABRIQUÉES PAR ET POUR RBCOMPONENTES



FABRICATO DA E PER RBCOMPONENTES
PRODUCED BY AND FOR RBCOMPONENTES

Email / Mail / Email: rbcomponentes@rbcomponentes.com
Movil / Portable / Mobile: +34 696 997 798 / +34 677 677 471

Telf. / Tél. / Phone: +34 976 400 421
Fax / Fax / Fax: +34 976 400 420







CAPOTS / COFANI / CAPOTS / COVERS

Item n°1 - Ref: RB013551



DESCRIPCIÓN / DESCRIZIONE / DESCRIPTION / DESCRIPTION:

-  CAPOT DE FIBRA DE VIDRIO, LADO DERECHO TRASERO.
-  COFANO IN FIBRA DI VETRO, LATO DESTRO POSTERIORE.
-  CAPOT EN FIBRE DE VERRE, CÔTÉ ARRIÈRE DROIT.
-  FIBER GLASS COVER, REAR RIGHT SIDE.





ENTREGA / CONSEGNA / LIVRAISON / DELIVERY DATE:

 IMMEDIATA / IMMEDIATA / IMMÉDIATE / IMMEDIATE.

Item n°2 - Ref: RB013550



DESCRIPCIÓN / DESCRIZIONE / DESCRIPTION / DESCRIPTION:

-  CAPOT DE FIBRA, LADO IZQUIERDO TRASERO.
-  COFANO IN FIBRA DI VETRO, LATO SINISTRO POSTERIORE.
-  CAPOT EN FIBRE DE VERRE, CÔTÉ ARRIÈRE GAUCHE.
-  FIBER GLASS COVER, REAR LEFT SIDE.





ENTREGA / CONSEGNA / LIVRAISON / DELIVERY DATE:

 IMMEDIATA / IMMEDIATA / IMMÉDIATE / IMMEDIATE.

Item n°3 - Ref: RB013553



DESCRIPCIÓN / DESCRIZIONE / DESCRIPTION / DESCRIPTION:

-  CAPOT DE FIBRA, LADO DERECHO DELANTERO.
-  COFANO IN FIBRA DE VETRO, LATO DESTRO ANTERIORE.
-  CAPOT EN FIBRE DE VERRE, CÔTÉ AVANT DROIT.
-  FIBER GLASS COVER, FRONT RIGHT SIDE.





ENTREGA / CONSEGNA / LIVRAISON / DELIVERY DATE:

 IMMEDIATA / IMMEDIATA / IMMÉDIATE / IMMEDIATE.

Item n°4 - Ref: RB013552



DESCRIPCIÓN / DESCRIZIONE / DESCRIPTION / DESCRIPTION:

-  CAPOT DE FIBRA, LADO IZQUIERDO DELANTERO.
-  COFANO IN FIBRA DE VETRO, LATO SINISTRO ANTERIORE.
-  CAPOT EN FIBRE DE VERRE, CÔTÉ AVANT GAUCHE.
-  FIBER GLASS COVER, FRONT LEFT SIDE.

ENTREGA / CONSEGNA / LIVRAISON / DELIVERY DATE:

 IMMEDIATA / IMMEDIATA / IMMÉDIATE / IMMEDIATE.



FABRICADO POR Y PARA RBCOMPONENTES
FABRIQUÉES PAR ET POUR RBCOMPONENTES



FABRICATO DA E PER RBCOMPONENTES
PRODUCED BY AND FOR RBCOMPONENTES



R-B COMPONENTES

CAPOTS / COFANI / CAPOTS / COVERS



Item n° Ref: 1A - RB013541 / 1B - RB014545



1A





NUEVA
NOUVELLE
NEW



1B

ANTIGUA
ANCIENNE
OLD

DESCRIPCIÓN / DESCRIZIONE / DESCRIPTION / DESCRIPTION:

-  CAPOT DE FIBRA, LADO DELANTERO.
-  COFANO IN FIBRA DE VETRO, CENTRALE ANTERIORE.
-  CAPOT EN FIBRE DE VERRE, AVANT CENTRAL.
-  FIBER GLASS COVER, FRONT CENTRAL.

ENTREGA / CONSEGNA / LIVRAISON / DELIVERY DATE:

 IMMEDIATA / IMMEDIATA / IMMÉDIATE / IMMEDIATE.



FABRICADO POR Y PARA RBCOMPONENTES
FABRIQUÉES PAR ET POUR RBCOMPONENTES



FABRICATO DA E PER RBCOMPONENTES
PRODUCED BY AND FOR RBCOMPONENTES

Email / Mail / Email: rbcomponentes@rbcomponentes.com
Movil / Portable / Mobile: +34 696 997 798 / +34 677 677 471

Telf. / Tél. / Phone: +34 976 400 421
Fax / Fax / Fax: +34 976 400 420







CAPOTS / COFANI / CAPOTS / COVERS

Item n°2A - Ref: RB013536



DESCRIPCIÓN / DESCRIZIONE / DESCRIPTION / DESCRIPTION:

-  NUEVA VERSION DE CAPOT, LADO DERECHO.
-  NUOVA VERSIONE DI COFANO, LATO DESTRO.
-  NOUVELLE VERSION DE CAPOT, CÔTÉ DROIT.
-  NEW VERSION OF COVER, RIGHT SIDE.





ENTREGA / CONSEGNA / LIVRAISON / DELIVERY DATE:

 IMMEDIATA / IMMÉDIATE / IMMEDIATE.

Item n°3A - Ref: RB013537



DESCRIPCIÓN / DESCRIZIONE / DESCRIPTION / DESCRIPTION:

-  NUEVA VERSION DE CAPOT, LADO IZQUIERDO.
-  NUOVA VERSIONE DI COFANO, LATO SINISTRO.
-  NOUVELLE VERSION DE CAPOT, CÔTÉ GAUCHE.
-  NEW VERSION OF COVER, LEFT SIDE.





ENTREGA / CONSEGNA / LIVRAISON / DELIVERY DATE:

 IMMEDIATA / IMMÉDIATE / IMMEDIATE.

Item n°2B - Ref: RB013546



DESCRIPCIÓN / DESCRIZIONE / DESCRIPTION / DESCRIPTION:

-  ANTIGUA VERSION DE CAPOT, LADO DERECHO.
-  VECCHIA VERSIONE DI COFANO, LATO DESTRO.
-  ANCIENNE VERSION DE CAPOT, CÔTÉ DROIT.
-  OLD VERSION OF COVER, RIGHT SIDE.





ENTREGA / CONSEGNA / LIVRAISON / DELIVERY DATE:

 IMMEDIATA / IMMÉDIATE / IMMEDIATE.

Item n°3B - Ref: RB013547



DESCRIPCIÓN / DESCRIZIONE / DESCRIPTION / DESCRIPTION:

-  ANTIGUA VERSION DE CAPOT, LADO IZQUIERDO.
-  VECCHIA VERSIONE DI COFANO, LATO SINISTRO.
-  ANCIENNE VERSION DE CAPOT, CÔTÉ GAUCHE.
-  OLD VERSION OF COVER, LEFT SIDE.

ENTREGA / CONSEGNA / LIVRAISON / DELIVERY DATE:

 IMMEDIATA / IMMÉDIATE / IMMEDIATE.



 FABRICADO POR Y PARA RBCOMPONENTES
 FABRIQUÉES PAR ET POUR RBCOMPONENTES

 FABRICATO DA E PER RBCOMPONENTES
 PRODUCED BY AND FOR RBCOMPONENTES

Email / Mail / Email: rbcomponentes@rbcomponentes.com
 Movil / Portable / Mobile: +34 696 997 798 / +34 677 677 471

Telf. / Tél. / Phone: +34 976 400 421
 Fax / Fax / Fax: +34 976 400 420



R-B COMPONENTES





CAPOTS / COFANI / CAPOTS / COVERS



Item n°1 - Ref: RB013519



DESCRIPCIÓN / DESCRIZIONE / DESCRIPTION / DESCRIPTION:

-  CAPOT DE FIBRA, LADO DELANTERO.
-  COFANO IN FIBRA DE VETRO, CENTRALE ANTERIORE.
-  CAPOT EN FIBRE DE VERRE, AVANT CENTRAL
-  FIBER GLASS COVER, FRONT CENTRAL.

ENTREGA / CONSEGNA / LIVRAISON / DELIVERY DATE:

 IMMEDIATA / IMMEDIATA / IMMÉDIATE / IMMEDIATE.



FABRICADO POR Y PARA RBCOMPONENTES
FABRIQUÉES PAR ET POUR RBCOMPONENTES



FABRICATO DA E PER RBCOMPONENTES
PRODUCED BY AND FOR RBCOMPONENTES

Email / Mail / Email: rbcomponentes@rbcomponentes.com
Movil / Portable / Mobile: +34 696 997 798 / +34 677 677 471

Telf. / Tél. / Phone: +34 976 400 421
Fax / Fax / Fax: +34 976 400 420







CAPOTS / COFANI / CAPOTS / COVERS



Item n°2A - Ref: RB013512



DESCRIPCIÓN / DESCRIZIONE / DESCRIPTION / DESCRIPTION:

-  CAPOT CON DOS CIERRES, LADO IZQUIERDO.
-  COFANO CON DUE SERRATURE, LATO SINISTRO.
-  CAPOT AVEC DEUX FERMETURES, CÔTÉ GAUCHE.
-  COVER WITH TWO LATCHES, LEFT SIDE.





ENTREGA / CONSEGNA / LIVRAISON / DELIVERY DATE:

 IMMEDIATA / IMMÉDIATE / IMMEDIATE.

Item n°3A - Ref: RB013511



DESCRIPCIÓN / DESCRIZIONE / DESCRIPTION / DESCRIPTION:

-  CAPOT CON DOS CIERRES, LADO DERECHO.
-  COFANO CON DUE SERRATURE, LATO DESTRO.
-  CAPOT AVEC DEUX FERMETURES, CÔTÉ DROIT.
-  COVER WITH TWO LATCHES, RIGHT SIDE.





ENTREGA / CONSEGNA / LIVRAISON / DELIVERY DATE:

 IMMEDIATA / IMMÉDIATE / IMMEDIATE.

Item n°2B - Ref: RB013517



DESCRIPCIÓN / DESCRIZIONE / DESCRIPTION / DESCRIPTION:

-  CAPOT CON UN CIERRE CENTRAL, LADO IZQUIERDO.
-  COFANO CON UNA SERRATURA, LATO SINISTRO.
-  CAPOT AVEC UNE FERMETURE AU CENTRE, CÔTÉ GAUCHE.
-  COVER WITH ONLY CENTER LACTH, LEFT SIDE.





ENTREGA / CONSEGNA / LIVRAISON / DELIVERY DATE:

 IMMEDIATA / IMMÉDIATE / IMMEDIATE.

Item n°3B - Ref: RB013516



DESCRIPCIÓN / DESCRIZIONE / DESCRIPTION / DESCRIPTION:

-  CAPOT CON UN CIERRE CENTRAL, LADO DERECHO.
-  COFANO CON UNA SERRATURA, LATO DESTRO.
-  CAPOT AVEC UNE FERMETURE AU CENTRE, CÔTÉ DROIT.
-  COVER WITH ONLY CENTER LACTH, RIGHT SIDE.

ENTREGA / CONSEGNA / LIVRAISON / DELIVERY DATE:

 IMMEDIATA / IMMÉDIATE / IMMEDIATE.



FABRICADO POR Y PARA RBCOMPONENTES
FABRIQUÉES PAR ET POUR RBCOMPONENTES



FABRICATO DA E PER RBCOMPONENTES
PRODUCED BY AND FOR RBCOMPONENTES



R-B COMPONENTES

CAPOTS / COFANI / CAPOTS / COVERS



FABRICADO POR Y PARA RBCOMPONENTES
FABRIQUÉES PAR ET POUR RBCOMPONENTES



FABRICATO DA E PER RBCOMPONENTES
PRODUCED BY AND FOR RBCOMPONENTES

Email / Mail / Email: rbcomponentes@rbcomponentes.com
Movil / Portable / Mobile: +34 696 997 798 / +34 677 677 471

Telf. / Tél. / Phone: +34 976 400 421
Fax / Fax / Fax: +34 976 400 420







CAPOTS / COFANI / CAPOTS / COVERS



Item n°1 - Ref: RB013502



DESCRIPCIÓN / DESCRIZIONE / DESCRIPTION / DESCRIPTION:

-  CAPOT DE FIBRA DE VIDRIO, LADO DERECHO.
-  COFANO IN FIBRA DI VETRO, LATO DESTRO.
-  CAPOT EN FIBRE DE VERRE, CÔTÉ DROIT.
-  FIBER GLASS COVER, RIGHT SIDE.





ENTREGA / CONSEGNA / LIVRAISON / DELIVERY DATE:

-  IMMEDIATA / IMMEDIATA / IMMÉDIATE / IMMEDIATE.

Item n°2 - Ref: RB013503



DESCRIPCIÓN / DESCRIZIONE / DESCRIPTION / DESCRIPTION:

-  CAPOT DE FIBRA DE VIDRIO, LADO IZQUIERDO.
-  COFANO IN FIBRA DI VETRO, LATO SINISTRO.
-  CAPOT EN FIBRE DE VERRE, CÔTÉ GAUCHE.
-  FIBER GLASS COVER, LEFT SIDE.

ENTREGA / CONSEGNA / LIVRAISON / DELIVERY DATE:

-  IMMEDIATA / IMMEDIATA / IMMÉDIATE / IMMEDIATE.



FABRICADO POR Y PARA RBCOMPONENTES
FABRIQUÉES PAR ET POUR RBCOMPONENTES

FABRICATO DA E PER RBCOMPONENTES
PRODUCED BY AND FOR RBCOMPONENTES

Email / Mail / Email: rbcomponentes@rbcomponentes.com
Movil / Portable / Mobile: +34 696 997 798 / +34 677 677 471

Telf. / Tél. / Phone: +34 976 400 421
Fax / Fax / Fax: +34 976 400 420



R-B COMPONENTES

CAPOTS / COFANI / CAPOTS / COVERS



FABRICADO POR Y PARA RBCOMPONENTES
FABRIQUÉES PAR ET POUR RBCOMPONENTES



FABRICATO DA E PER RBCOMPONENTES
PRODUCED BY AND FOR RBCOMPONENTES

Email / Mail / Email: rbcomponentes@rbcomponentes.com
Movil / Portable / Mobile: +34 696 997 798 / +34 677 677 471

Telf. / Tél. / Phone: +34 976 400 421
Fax / Fax / Fax: +34 976 400 420







CAPOTS / COFANI / CAPOTS / COVERS



Item n°1 - Ref: RB013500



DESCRIPCIÓN / DESCRIZIONE / DESCRIPTION / DESCRIPTION:

-  CAPOT DE FIBRA DE VIDRIO, LADO DERECHO.
-  COFANO IN FIBRA DI VETRO, LATO DESTRO.
-  CAPOT EN FIBRE DE VERRE, CÔTÉ DROIT.
-  FIBER GLASS COVER, RIGHT SIDE.





ENTREGA / CONSEGNA / LIVRAISON / DELIVERY DATE:

 IMMEDIATA / IMMEDIATA / IMMÉDIATE / IMMEDIATE.

Item n°2 - Ref: RB013501



DESCRIPCIÓN / DESCRIZIONE / DESCRIPTION / DESCRIPTION:

-  CAPOT DE FIBRA DE VIDRIO, LADO IZQUIERDO.
-  COFANO IN FIBRA DI VETRO, LATO SINISTRO.
-  CAPOT EN FIBRE DE VERRE, CÔTÉ GAUCHE.
-  FIBER GLASS COVER, LEFT SIDE.





ENTREGA / CONSEGNA / LIVRAISON / DELIVERY DATE:

 IMMEDIATA / IMMEDIATA / IMMÉDIATE / IMMEDIATE.

Item n°3 - Ref: RB013529



DESCRIPCIÓN / DESCRIZIONE / DESCRIPTION / DESCRIPTION:

-  CAPOT DE FIBRA, LADO DELANTERO.
-  COFANO IN FIBRA DE VETRO, CENTRALE ANTERIORE.
-  CAPOT EN FIBRE DE VERRE, AVANT CENTRAL
-  FIBER GLASS COVER, FRONT CENTRAL.

ENTREGA / CONSEGNA / LIVRAISON / DELIVERY DATE:

 IMMEDIATA / IMMEDIATA / IMMÉDIATE / IMMEDIATE.



FABRICADO POR Y PARA RBCOMPONENTES
FABRIQUÉES PAR ET POUR RBCOMPONENTES

FABRICATO DA E PER RBCOMPONENTES
PRODUCED BY AND FOR RBCOMPONENTES

Email / Mail / Email: rbcomponentes@rbcomponentes.com
Movil / Portable / Mobile: +34 696 997 798 / +34 677 677 471

Telf. / Tél. / Phone: +34 976 400 421
Fax / Fax / Fax: +34 976 400 420



R-B COMPONENTES

CAPOTS / COFANI / CAPOTS / COVERS



FABRICADO POR Y PARA RBCOMPONENTES
FABRIQUÉES PAR ET POUR RBCOMPONENTES



FABRICATO DA E PER RBCOMPONENTES
PRODUCED BY AND FOR RBCOMPONENTES

Email / Mail / Email: rbcomponentes@rbcomponentes.com
Movil / Portable / Mobile: +34 696 997 798 / +34 677 677 471

Telf. / Tél. / Phone: +34 976 400 421
Fax / Fax / Fax: +34 976 400 420







CAPOTS / COFANI / CAPOTS / COVERS



Item n°1 - Ref: RB013510



DESCRIPCIÓN / DESCRIZIONE / DESCRIPTION / DESCRIPTION:

-  CAPOT DE FIBRA DE VIDRIO, LADO DERECHO.
-  COFANO IN FIBRA DI VETRO, LATO DESTRO.
-  CAPOT EN FIBRE DE VERRE, CÔTÉ DROIT.
-  FIBER GLASS COVER, RIGHT SIDE.





ENTREGA / CONSEGNA / LIVRAISON / DELIVERY DATE:

 IMMEDIATA / IMMEDIATA / IMMÉDIATE / IMMEDIATE.

Item n°2 - Ref: RB013509



DESCRIPCIÓN / DESCRIZIONE / DESCRIPTION / DESCRIPTION:

-  CAPOT DE FIBRA, LADO IZQUIERDO.
-  COFANO IN FIBRA DI VETRO, LATO SINISTRO.
-  CAPOT EN FIBRE DE VERRE, CÔTÉ GAUCHE.
-  FIBER GLASS COVER, LEFT SIDE.





ENTREGA / CONSEGNA / LIVRAISON / DELIVERY DATE:

 IMMEDIATA / IMMEDIATA / IMMÉDIATE / IMMEDIATE.

Item n°3 - Ref: RB013518



DESCRIPCIÓN / DESCRIZIONE / DESCRIPTION / DESCRIPTION:

-  CAPOT DE FIBRA, LADO DELANTERO.
-  COFANO IN FIBRA DE VETRO, CENTRALE ANTERIORE.
-  CAPOT EN FIBRE DE VERRE, AVANT CENTRAL
-  FIBER GLASS COVER, FRONT CENTRAL.





ENTREGA / CONSEGNA / LIVRAISON / DELIVERY DATE:

 IMMEDIATA / IMMEDIATA / IMMÉDIATE / IMMEDIATE.

Item n°4 - Ref: RB013528



DESCRIPCIÓN / DESCRIZIONE / DESCRIPTION / DESCRIPTION:

-  CAPOT DE FIBRA, LADO TRASERO.
-  COFANO IN FIBRA DI VETRO, CENTRALE POSTERIORE.
-  CAPOT EN FIBRE DE VERRE, ARRIÈRE CENTRAL.
-  FIBER GLASS COVER, REAR SIDE.

ENTREGA / CONSEGNA / LIVRAISON / DELIVERY DATE:

 IMMEDIATA / IMMEDIATA / IMMÉDIATE / IMMEDIATE.



FABRICADO POR Y PARA RBCOMPONENTES
FABRIQUÉES PAR ET POUR RBCOMPONENTES



FABRICATO DA E PER RBCOMPONENTES
PRODUCED BY AND FOR RBCOMPONENTES

Email / Mail / Email: rbcomponentes@rbcomponentes.com
Movil / Portable / Mobile: +34 696 997 798 / +34 677 677 471

Telf. / Tél. / Phone: +34 976 400 421
Fax / Fax / Fax: +34 976 400 420



R-B COMPONENTES

CAPOTS / COFANI / CAPOTS / COVERS

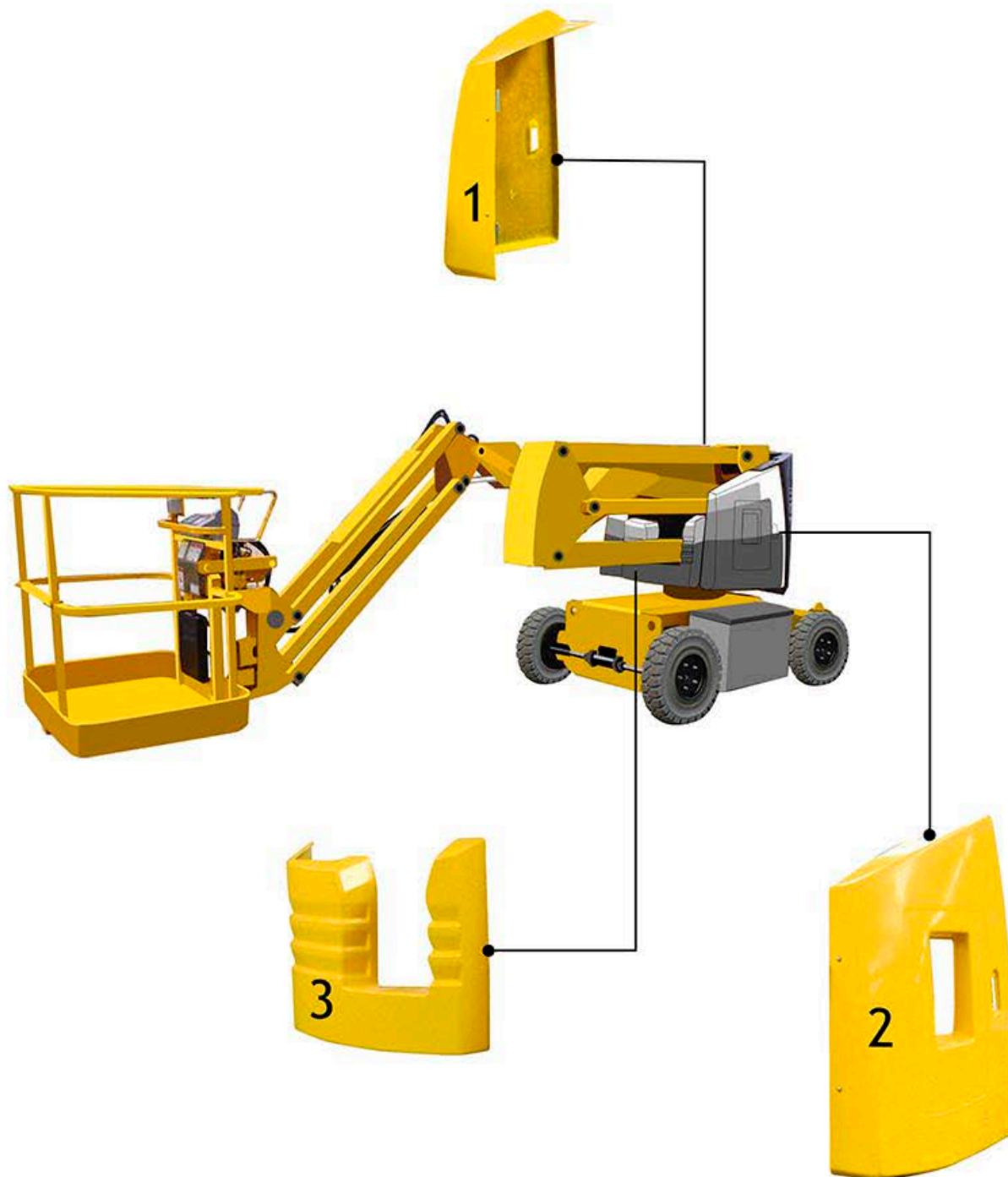

FABRICADO POR Y PARA RBCOMPONENTES
FABRIQUÉES PAR ET POUR RBCOMPONENTES



FABRICATO DA E PER RBCOMPONENTES
PRODUCED BY AND FOR RBCOMPONENTES

Email / Mail / Email: rbcomponentes@rbcomponentes.com
Movil / Portable / Mobile: +34 696 997 798 / +34 677 677 471

Telf. / Tél. / Phone: +34 976 400 421
Fax / Fax / Fax: +34 976 400 420







CAPOTS / COFANI / CAPOTS / COVERS



Item n°1 - Ref: RB013510



DESCRIPCIÓN / DESCRIZIONE / DESCRIPTION / DESCRIPTION:

-  CAPOT DE FIBRA DE VIDRIO, LADO DERECHO.
-  COFANO IN FIBRA DI VETRO, LATO DESTRO.
-  CAPOT EN FIBRE DE VERRE, CÔTÉ DROIT.
-  FIBER GLASS COVER, RIGHT SIDE.





ENTREGA / CONSEGNA / LIVRAISON / DELIVERY DATE:

 IMMEDIATA / IMMEDIATA / IMMÉDIATE / IMMEDIATE.

Item n°2 - Ref: RB013515



DESCRIPCIÓN / DESCRIZIONE / DESCRIPTION / DESCRIPTION:

-  CAPOT DE FIBRA, LADO IZQUIERDO.
-  COFANO IN FIBRA DI VETRO, LATO SINISTRO.
-  CAPOT EN FIBRE DE VERRE, CÔTÉ GAUCHE.
-  FIBER GLASS COVER, LEFT SIDE.





ENTREGA / CONSEGNA / LIVRAISON / DELIVERY DATE:

 IMMEDIATA / IMMEDIATA / IMMÉDIATE / IMMEDIATE.

Item n°3 - Ref: RB013518



DESCRIPCIÓN / DESCRIZIONE / DESCRIPTION / DESCRIPTION:

-  CAPOT DE FIBRA, LADO DELANTERO.
-  COFANO IN FIBRA DE VETRO, CENTRALE ANTERIORE.
-  CAPOT EN FIBRE DE VERRE, AVANT CENTRAL
-  FIBER GLASS COVER, FRONT CENTRAL.

ENTREGA / CONSEGNA / LIVRAISON / DELIVERY DATE:

 IMMEDIATA / IMMEDIATA / IMMÉDIATE / IMMEDIATE.



FABRICADO POR Y PARA RBCOMPONENTES
FABRIQUÉES PAR ET POUR RBCOMPONENTES

FABRICATO DA E PER RBCOMPONENTES
PRODUCED BY AND FOR RBCOMPONENTES

Email / Mail / Email: rbcomponentes@rbcomponentes.com
Movil / Portable / Mobile: +34 696 997 798 / +34 677 677 471

Telf. / Tél. / Phone: +34 976 400 421
Fax / Fax / Fax: +34 976 400 420



R-B COMPONENTES

CAPOTS / COFANI / CAPOTS / COVERS

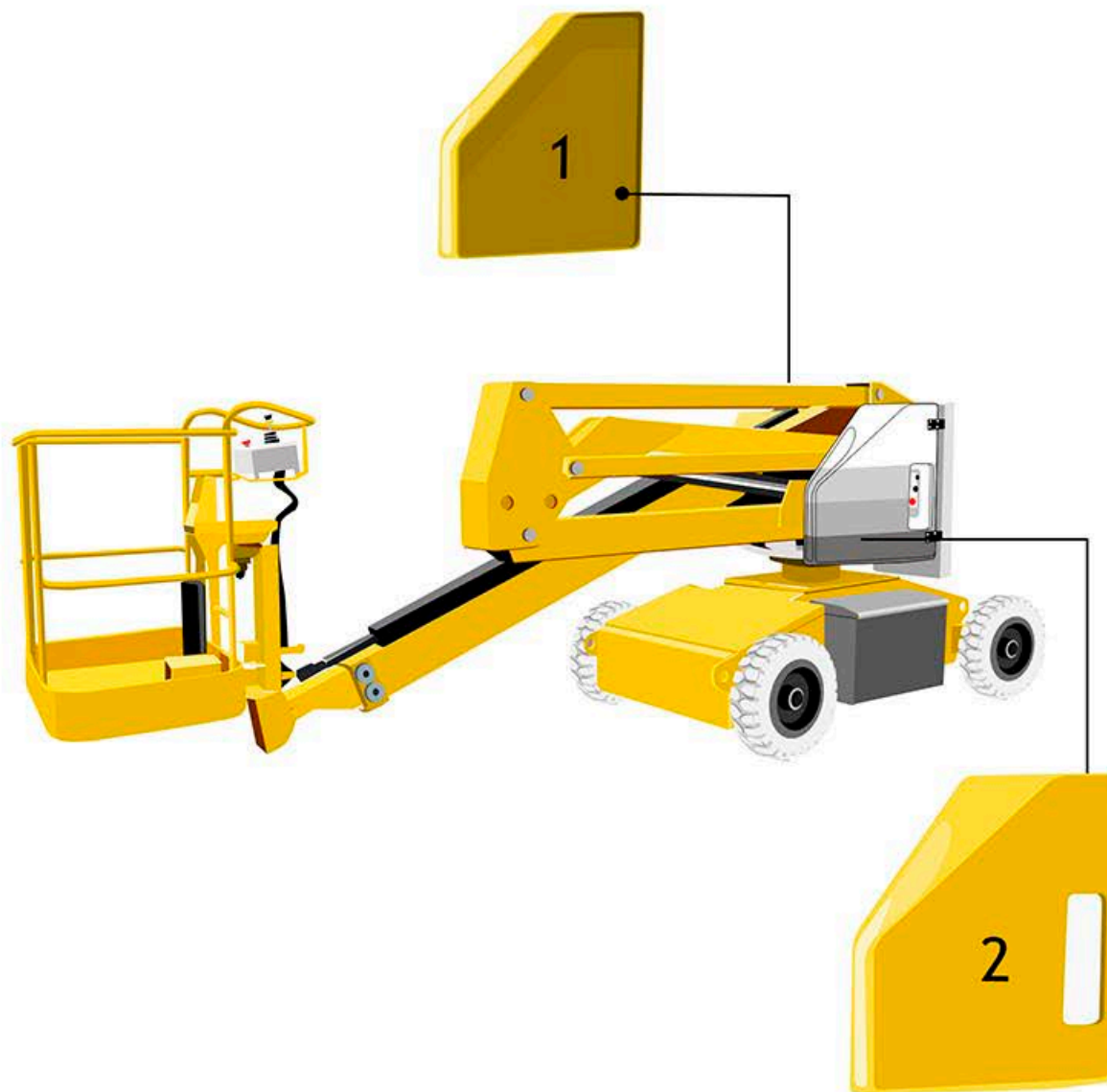

FABRICADO POR Y PARA RBCOMPONENTES
FABRIQUÉES PAR ET POUR RBCOMPONENTES



FABRICATO DA E PER RBCOMPONENTES
PRODUCED BY AND FOR RBCOMPONENTES

Email / Mail / Email: rbcomponentes@rbcomponentes.com
Movil / Portable / Mobile: +34 696 997 798 / +34 677 677 471

Telf. / Tél. / Phone: +34 976 400 421
Fax / Fax / Fax: +34 976 400 420







CAPOTS / COFANI / CAPOTS / COVERS

Item n°1 - Ref: RB013527



DESCRIPCIÓN / DESCRIZIONE / DESCRIPTION / DESCRIPTION:

-  CAPOT DE FIBRA DE VIDRIO, LADO DERECHO.
-  COFANO IN FIBRA DI VETRO, LATO DESTRO.
-  CAPOT EN FIBRE DE VERRE, CÔTÉ DROIT.
-  FIBER GLASS COVER, RIGHT SIDE.





ENTREGA / CONSEGNA / LIVRAISON / DELIVERY DATE:

 IMMEDIATA / IMMEDIATA / IMMÉDIATE / IMMEDIATE.

Item n°2 - Ref: RB013526



DESCRIPCIÓN / DESCRIZIONE / DESCRIPTION / DESCRIPTION:

-  CAPOT DE FIBRA, LADO IZQUIERDO.
-  COFANO IN FIBRA DI VETRO, LATO SINISTRO.
-  CAPOT EN FIBRE DE VERRE, CÔTÉ GAUCHE.
-  FIBER GLASS COVER, LEFT SIDE.

ENTREGA / CONSEGNA / LIVRAISON / DELIVERY DATE:

 IMMEDIATA / IMMEDIATA / IMMÉDIATE / IMMEDIATE.



 FABRICADO POR Y PARA RBCOMPONENTES
 FABRIQUÉES PAR ET POUR RBCOMPONENTES

 FABRICATO DA E PER RBCOMPONENTES
 PRODUCED BY AND FOR RBCOMPONENTES

Email / Mail / Email: rbcomponentes@rbcomponentes.com
Movil / Portable / Mobile: +34 696 997 798 / +34 677 677 471

Telf. / Tél. / Phone: +34 976 400 421
Fax / Fax / Fax: +34 976 400 420



R-B COMPONENTES



CAPOTS / COFANI / CAPOTS / COVERS

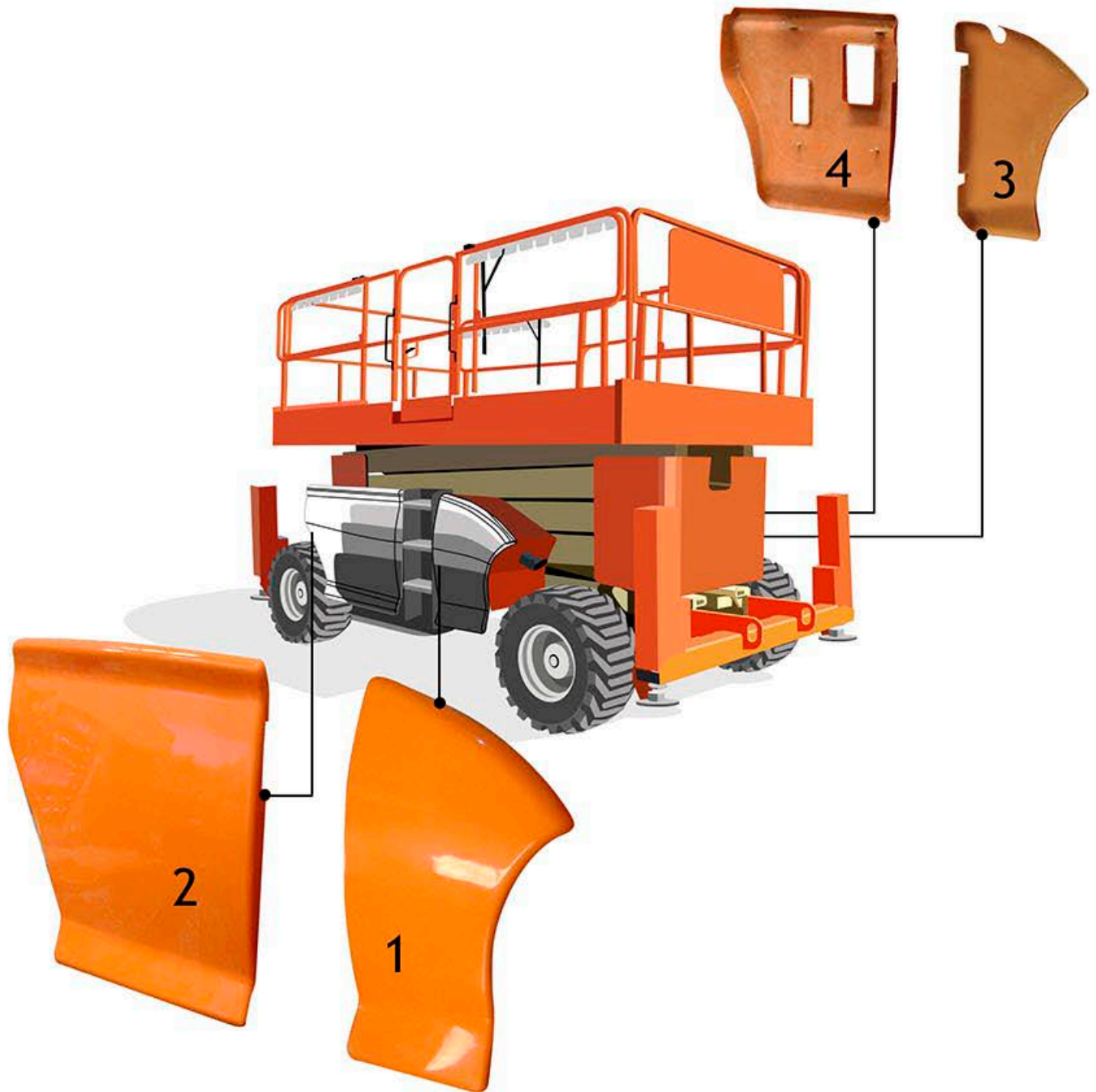

FABRICADO POR Y PARA RBCOMPONENTES

FABRIQUÉES PAR ET POUR RBCOMPONENTES



FABRICATO DA E PER RBCOMPONENTES

PRODUCED BY AND FOR RBCOMPONENTES

Email / Mail / Email: rbcomponentes@rbcomponentes.com

Movil / Portable / Mobile: +34 696 997 798 / +34 677 677 471

Telf. / Tél. / Phone: +34 976 400 421

Fax / Fax / Fax: +34 976 400 420







CAPOTS / COFANI / CAPOTS / COVERS

Item n°1 - Ref: RB013562



DESCRIPCIÓN / DESCRIZIONE / DESCRIPTION / DESCRIPTION:

-  CAPOT DE FIBRA, LADO DERECHO DELANTERO.
-  COFANO IN FIBRA DE VETRO, LATO DESTRO ANTERIORE.
-  CAPOT EN FIBRE DE VERRE, CÔTÉ AVANT DROIT.
-  FIBER GLASS COVER, FRONT RIGHT SIDE.





ENTREGA / CONSEGNA / LIVRAISON / DELIVERY DATE:

 IMMEDIATA / IMMEDIATA / IMMÉDIATE / IMMEDIATE.

Item n°2 - Ref: RB013564



DESCRIPCIÓN / DESCRIZIONE / DESCRIPTION / DESCRIPTION:

-  CAPOT DE FIBRA DE VIDRIO, LADO DERECHO TRASERO.
-  COFANO IN FIBRA DI VETRO, LATO DESTRO POSTERIORE.
-  CAPOT EN FIBRE DE VERRE, CÔTÉ ARRIÈRE DROIT.
-  FIBER GLASS COVER, REAR RIGHT SIDE.





ENTREGA / CONSEGNA / LIVRAISON / DELIVERY DATE:

 IMMEDIATA / IMMEDIATA / IMMÉDIATE / IMMEDIATE.

Item n°3 - Ref: RB013561



DESCRIPCIÓN / DESCRIZIONE / DESCRIPTION / DESCRIPTION:

-  CAPOT DE FIBRA, LADO IZQUIERDO DELANTERO.
-  COFANO IN FIBRA DE VETRO, LATO SINISTRO ANTERIORE.
-  CAPOT EN FIBRE DE VERRE, CÔTÉ AVANT GAUCHE.
-  FIBER GLASS COVER, FRONT LEFT SIDE.





ENTREGA / CONSEGNA / LIVRAISON / DELIVERY DATE:

 IMMEDIATA / IMMEDIATA / IMMÉDIATE / IMMEDIATE.

Item n°4 - Ref: RB013563



DESCRIPCIÓN / DESCRIZIONE / DESCRIPTION / DESCRIPTION:

-  CAPOT DE FIBRA, LADO IZQUIERDO TRASERO.
-  COFANO IN FIBRA DI VETRO, LATO SINISTRO POSTERIORE.
-  CAPOT EN FIBRE DE VERRE, CÔTÉ ARRIÈRE GAUCHE.
-  FIBER GLASS COVER, REAR LEFT SIDE.

ENTREGA / CONSEGNA / LIVRAISON / DELIVERY DATE:

 IMMEDIATA / IMMEDIATA / IMMÉDIATE / IMMEDIATE.



FABRICADO POR Y PARA RBCOMPONENTES
FABRIQUÉES PAR ET POUR RBCOMPONENTES



FABRICATO DA E PER RBCOMPONENTES
PRODUCED BY AND FOR RBCOMPONENTES

Email / Mail / Email: rbcomponentes@rbcomponentes.com
Movil / Portable / Mobile: +34 696 997 798 / +34 677 677 471

Telf. / Tél. / Phone: +34 976 400 421
Fax / Fax / Fax: +34 976 400 420



R-B COMPONENTES

CAPOTS / COFANI / CAPOTS / COVERS



160ATJ



FABRICADO POR Y PARA RBCOMPONENTES
FABRIQUÉES PAR ET POUR RBCOMPONENTES



FABRICATO DA E PER RBCOMPONENTES
PRODUCED BY AND FOR RBCOMPONENTES

Email / Mail / Email: rbcomponentes@rbcomponentes.com
Movil / Portable / Mobile: +34 696 997 798 / +34 677 677 471

Telf. / Tél. / Phone: +34 976 400 421
Fax / Fax / Fax: +34 976 400 420







CAPOTS / COFANI / CAPOTS / COVERS



Item n°1 - Ref: RB013570.3020



DESCRIPCIÓN / DESCRIZIONE / DESCRIPTION / DESCRIPTION:

-  CAPOT DE FIBRA, LADO DERECHO.
-  COFANO IN FIBRA DE VETRO, LATO DESTRO.
-  CAPOT EN FIBRE DE VERRE, CÔTÉ DROIT.
-  FIBER GLASS COVER, RIGHT SIDE.





ENTREGA / CONSEGNA / LIVRAISON / DELIVERY DATE:

 IMMEDIATA / IMMEDIATA / IMMÉDIATE / IMMEDIATE.

Item n°2 - Ref: RB013569.3020



DESCRIPCIÓN / DESCRIZIONE / DESCRIPTION / DESCRIPTION:

-  CAPOT DE FIBRA, LADO IZQUIERDO.
-  COFANO IN FIBRA DE VETRO, LATO SINISTRO.
-  CAPOT EN FIBRE DE VERRE, CÔTÉ GAUCHE.
-  FIBER GLASS COVER, LEFT SIDE.

ENTREGA / CONSEGNA / LIVRAISON / DELIVERY DATE:

 IMMEDIATA / IMMEDIATA / IMMÉDIATE / IMMEDIATE.



 FABRICADO POR Y PARA RBCOMPONENTES
 FABRIQUÉES PAR ET POUR RBCOMPONENTES

 FABRICATO DA E PER RBCOMPONENTES
 PRODUCED BY AND FOR RBCOMPONENTES

Email / Mail / Email: rbcomponentes@rbcomponentes.com
Movil / Portable / Mobile: +34 696 997 798 / +34 677 677 471

Telf. / Tél. / Phone: +34 976 400 421
Fax / Fax / Fax: +34 976 400 420